



R99P - R99E

Rotary Analog Valve Positioners

Single & double-acting Positioner, input signal 4÷20mA (R99E) or 0.2÷1bar (R99P) for proportional control of rotary actuators. The positioner operates on the force-balance principle by comparing the standard signal transmitted from a pneumatic or an electronic controller device and the angular rotation of the stem, and conveys a positioning amplified pressure to the valve actuator.



Available 2014/34/UE (ATEX):

- II 1G Ex ia IIC Ga T6,T5 Ga
- II 2G IIC Ex h IIC T6...T1 Gb
- II 2D IIC Ex h IIC T6...T1 Db



CESI



- ◆ Good dynamic response
- ◆ Particular compact design
- ◆ Zero and Span independent adjustment
- ◆ Split-Range operation
- ◆ Insensitive to pressure variation
- ◆ Namur standard brachet (VDI/VDE 3845)
- ◆ Adjustable positioning pressure range
- ◆ Valve speed adjustment
- ◆ Reverse action
- ◆ Double acting operation
- ◆ 3D Position indicator

TECHNICAL DATA

MOUNTING	ISO recommended mounting bracket
PROTECTION CLASS (acc. To EN 60529)	IP55 (IP65 on request)
NOMINAL STROKE	0÷90° (std.) 0÷60° (std.) 0÷20° (on request) 0÷180° (on request) 0÷270° (on request) 0÷360° (on request) Equal percentage EQP (on request) other cam (on request)
PNEUMATIC CONNECTION	1/4" NPT
SUPPLY AIR PRESSURE	3...10 bar
OUTPUT AIR PRESSURE	0...100% of the supply air pressure
REPEATIBILITY	R99P: ±0.1% F.S. R99E: ±0.2% F.S.
HISTERESIS	R99P: ±0.6% F.S. R99E: ±1.0% F.S.
INPUT SIGNAL	R99P: 3÷15 psi (other input on request) R99E: 4÷20 mA (other input on request)
ANBIENT TEMPERATURE	R99P: -40÷80°C RE01: -40÷70°C
ELECTRIC CONNECTION	R99E: Cable gland PG9 (other on request)
Ui	R99E: < 30 V
Ii	R99E: < 150 mA
Pi	R99E: < 0.8 W
Impedance	R99E: < 250 Ohm
Ci	negligible
Li	negligible
WEIGHT	R99P: 1,3 Kg R99E: 1,4 Kg
BODY MATERIAL	Die cast aluminium with anti corrosive paint
COVER MATERIAL	Polycarbonate
RECEIVER DIAPHRAGM	Nitrile rubber

OPTIONS

POSITION TRANSMITTER (4÷20mA)	LIMIT SWITCHES
COVER IN DIE CAST ALLUMINIUM	PRESSURE GAUGE (GMKit)
II 1G Ex ia IIC Ga T6,T5 Ga (PVP11BE.1)	I 2D IIC Ex h IIIC T6...T1 Db (R99P)
	II 2G IIC Ex h IIC T6...T1 Gb (R99P)

AVAILABLE CAM

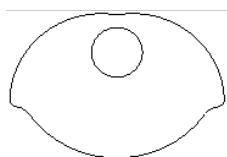

20°/30°CAM

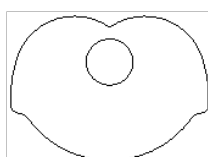

60°/90°CAM

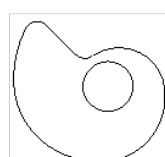

180°/270° CAM

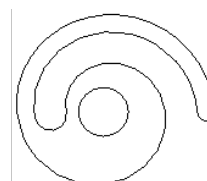

360° CAM

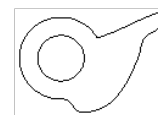

90° eqp CAM

AIR DELIVERY

Test effected with pipe 6x8 mm

AIR SUPPLY (bar)	AIR DELIVERY (Nm ³ /h)	AIR CONSUMPTION (Nm ³ /h)
2	from 1 to 10	0.2
4	from 1 to 16	0.5
6	from 1 to 22	0.7
8	from 1 to 28	1.0
10	from 1 to 34	1.4

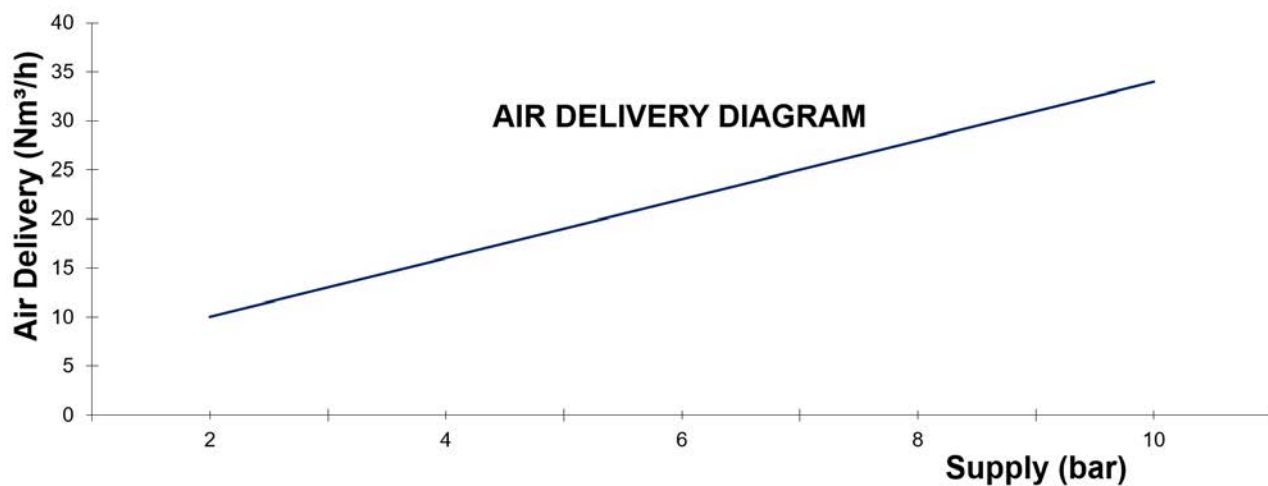

DIMENSIONS

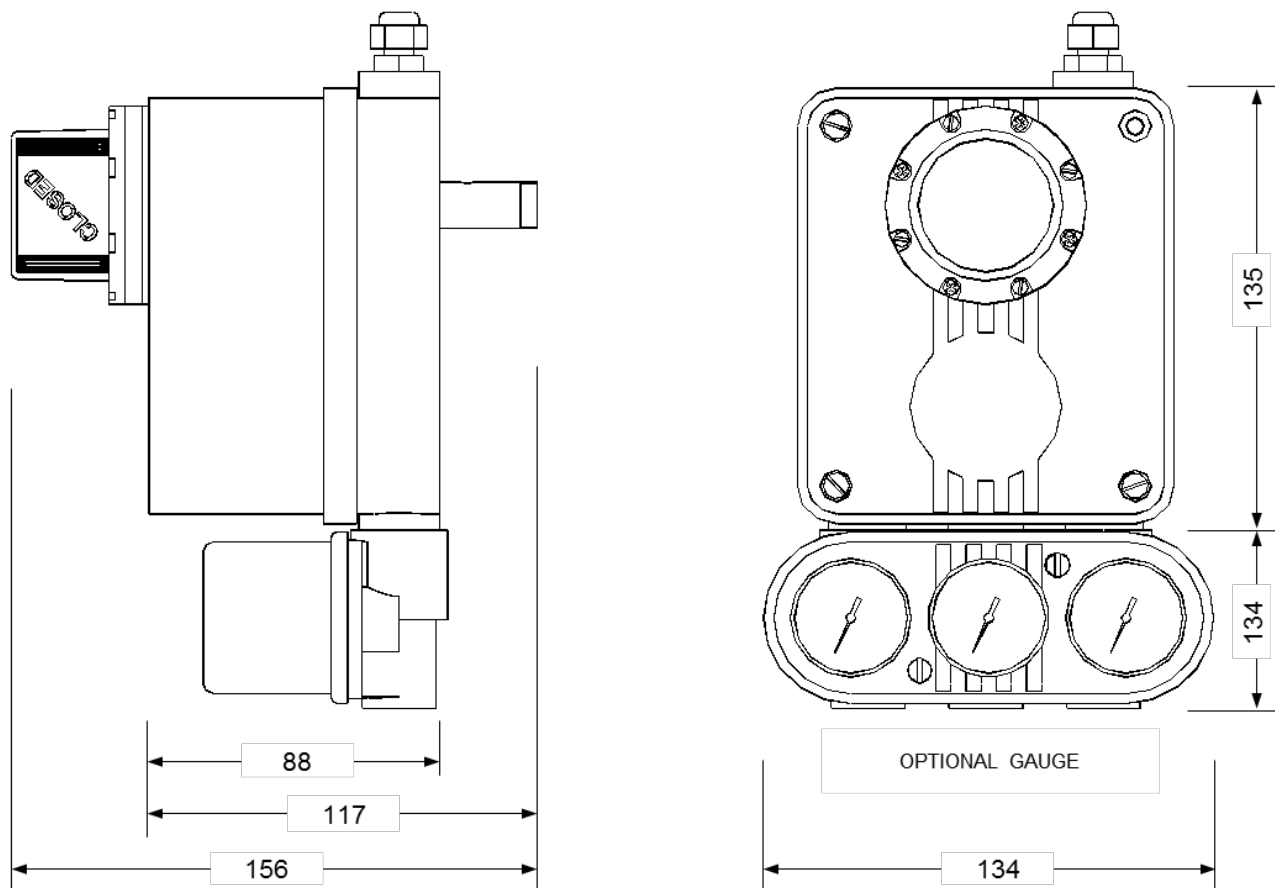

The contents of this publication are presented for information purpose only. We reserve to modify or improve the designs or specifications of such products at any time without notice



OMC S.p.A.

Via Galileo Galilei, 18 - 20060
Cassina de Pecchi (MI) - ITALY
Tel.: (+39) 02.95.28.468
Fax: (+39) 02.95.21.495
info@omcvalves.com
www.omcvalves.com